

BUCĂTĂRIE DULAP JOS JH-200-350

INSTRUCȚIUNI DE ASAMBLARE / ASSEMBLY INSTRUCTIONS

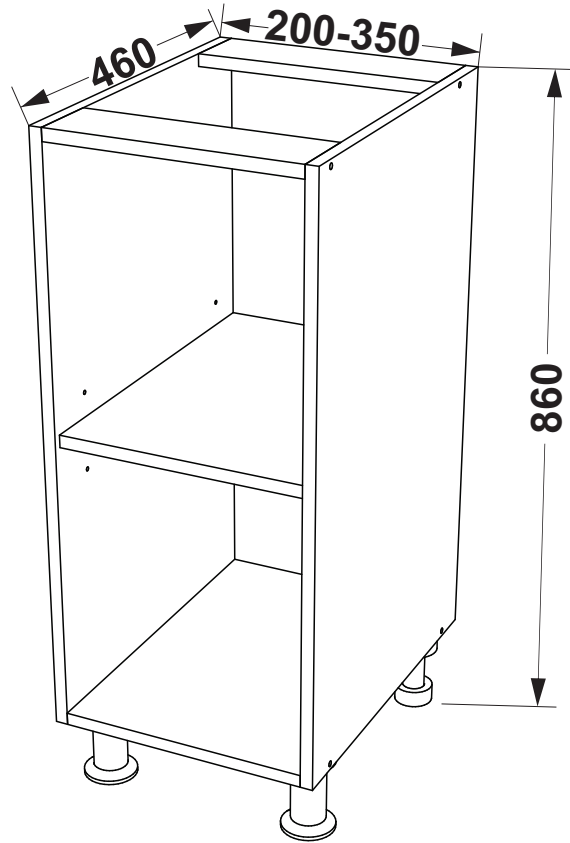

REGULI DE FUNCȚIONARE:

1. Este necesar să se evite deschiderea și închiderea bruscă a ușilor. Astfel de acțiuni pot strica reglajele de instalare sau pot duce la scoaterea din funcție a elementelor de fixare de pe panouri.
2. Piesele structurale nu sunt proiectate pentru sarcini crescute. Greutatea maximă pentru care sunt proiectate elementele de fixare a raftului este de 25 kg.
3. Mecanismele de deschidere a ușilor nu au nevoie de lubrifiere suplimentară, dar nu le plac pătrunderea părului, nisipului și prafului. Acestea trebuie scoase periodic din dulap.
4. Este necesar să se protejeze suprafețele laminat de contactul cu solvenți (alcool, benzină, acetonă, acizi, etc.). Dulapurile ar trebui șterse cu o cârpă moale, ușor umedă.
5. Acest dulap este proiectat numai pentru asamblare orizontală, nu este asigurat montajul vertical.
6. Dacă este necesară înlocuirea componentelor sau instalarea parțială (completă) sau demontarea structurii cabinetului, ar trebui să implice profesioniști, meșteri sau instalatori.
7. Mobilierul nou poate avea un miros natural din materialele din care este fabricat. Mirosul poate persista 3 săptămâni de la data asamblării. Pentru a reduce intensitatea mirosului, se recomandă: pentru mobila dulap - ștergeți cu o cârpă umezită într-un detergent slab, ștergeți cu o cârpă curată uscată și aerisiți încăperea deschizând mai întâi toate ușile și sertarele produsului. Acești pași trebuie repetați de 3-4 ori pe zi.

Garantia pentru garderoba este indicată în codul QR de pe site în secțiunea pentru acest produs. Producătorul are dreptul de a contesta garanția în cazul în care există nerespectarea de către client a regulilor de funcționare.

OPERATING RULES:

1. It is necessary to avoid sudden opening and closing of doors. Such actions may affect the installation adjustments or damage the fastening elements on the panels.
2. Structural parts are not designed for increased loads (they cannot support leaning elbows, heavy strikes, or be used as stairs, and so on). The maximum weight for which the shelf fastenings are designed is 25 kg.
3. Door opening mechanisms do not need additional lubrication, but they do not tolerate the ingress of hair, sand, and dust. They must be periodically removed from the cabinet.
4. It is necessary to protect laminated surfaces from contact with solvents (alcohol, gasoline, acetone, acids, alkalis, etc.). Cabinets should be wiped with a soft, slightly damp cloth, using special cabinet furniture polishes or a soap solution.
5. This cabinet is designed for horizontal assembly only; vertical assembly is not provided.
6. If it is necessary to replace components or perform partial (full) installation or dismantling of the cabinet structure, it should involve professional master installers.
7. New furniture may have a natural odor from the materials it is made of. The smell can persist for up to 3 weeks from the date of assembly. To reduce the intensity of the odor, it is recommended: for cabinet furniture - wipe with a cloth dampened in a mild detergent, wipe with a clean dry cloth, and ventilate the room by first opening all doors and drawers of the product. These steps must be repeated 3-4 times a day.

The warranty for the wardrobe is indicated in the QR code on the website in the section for this product. The manufacturer has the right to challenge the warranty if there is non-compliance by the customer with the operating rules or if there are independent changes to the design or replacement of cabinet components.

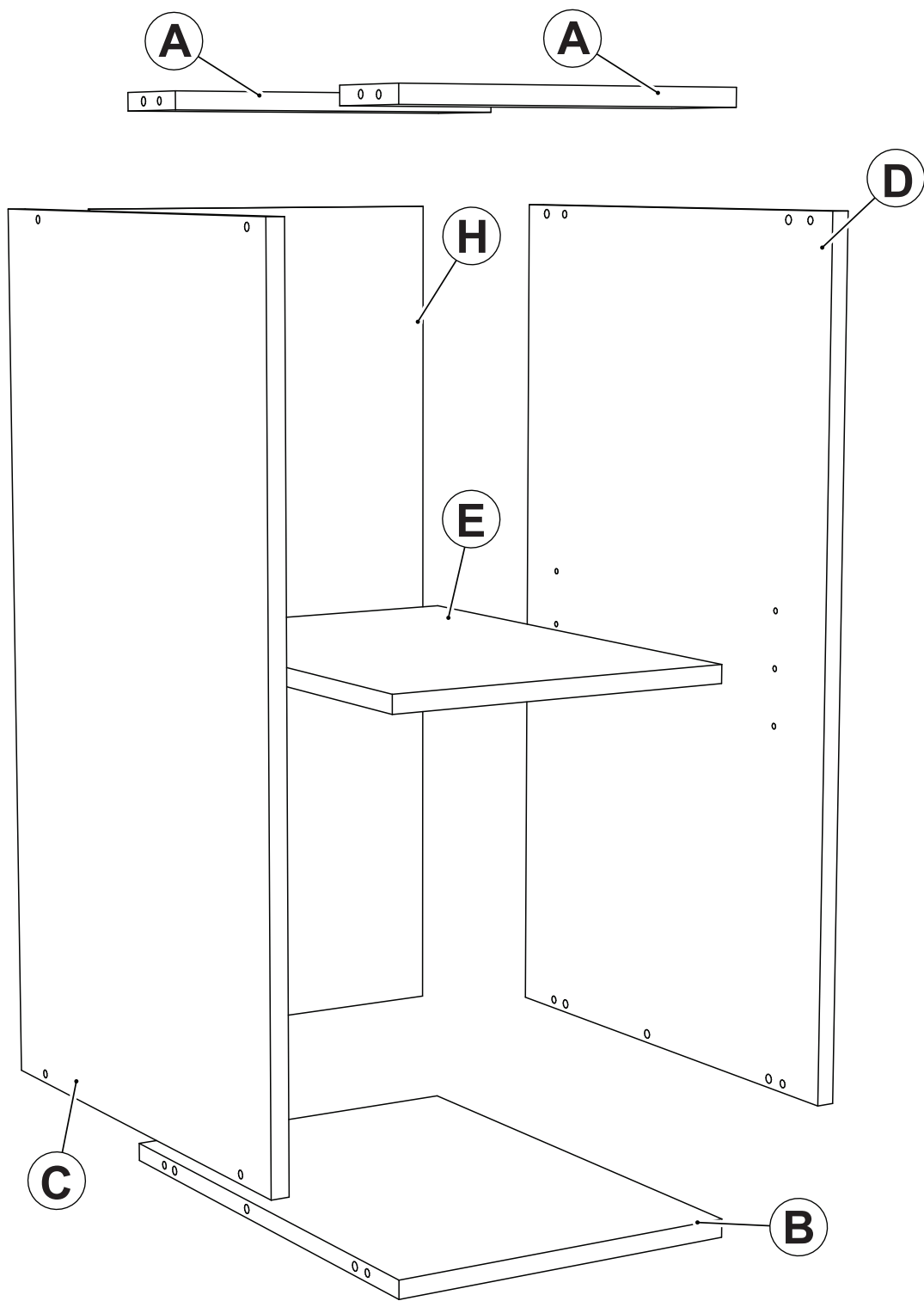

	200	250	300	350
A	168x90x16(2)	218x90x16(2)	268x90x16(2)	318x90x16(2)
B	168x460x16(1)	218x460x16(1)	268x460x16(1)	318x460x16(1)
C	760x460x16(1)	760x460x16(1)	760x460x16(1)	760x460x16(1)
D	760x460x16(1)	760x460x16(1)	760x460x16(1)	760x460x16(1)
E	168x450x16(1)	218x450x16(1)	268x450x16(1)	318x450x16(1)
H	757x196x3(1)	757x246x3(1)	757x296x3(1)	757x346x3(1)

ACCESORII ȘI MECANISME / /ACCESSORIES AND MECHANISMS

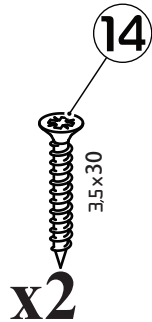
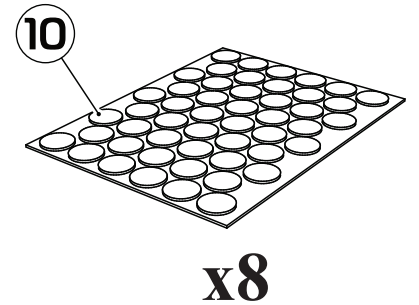
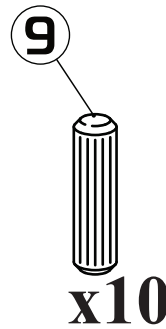
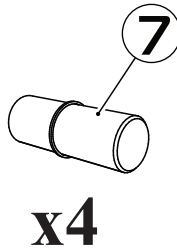
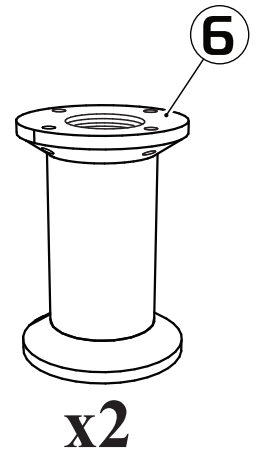
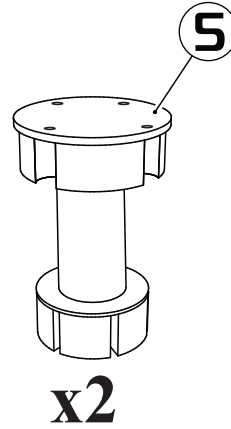
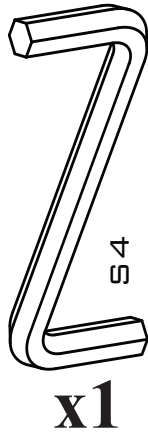
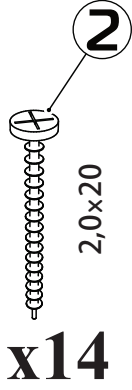
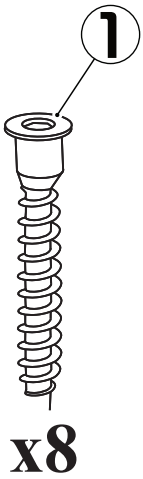

UNELTE ȘI ECHIPAMENTE / /TOOLS AND EQUIPMENT

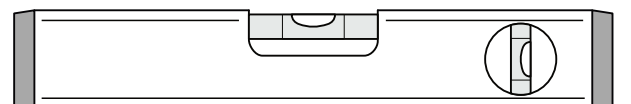
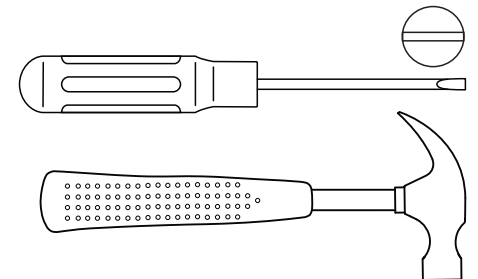
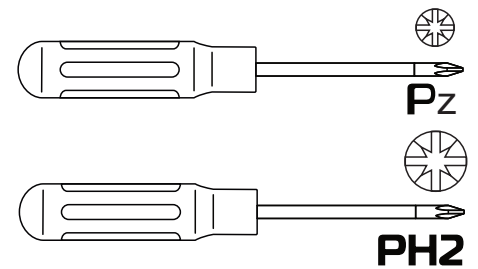
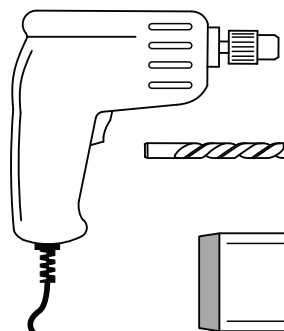
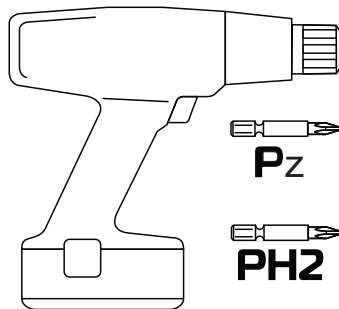
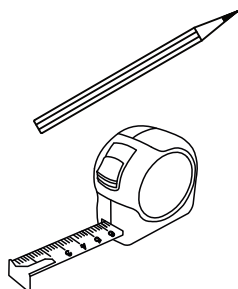
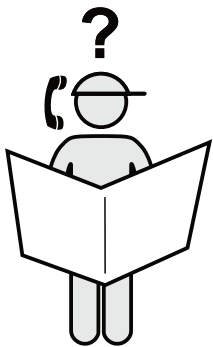

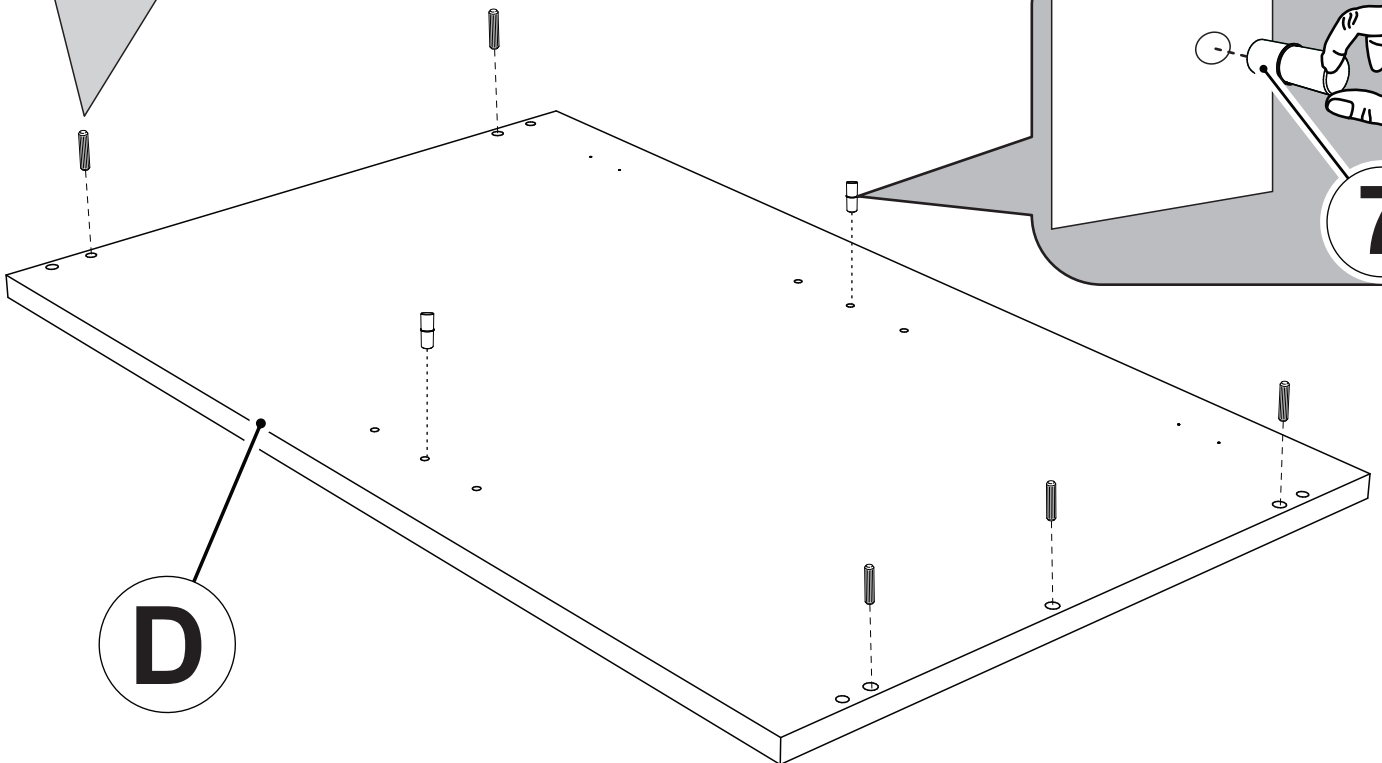
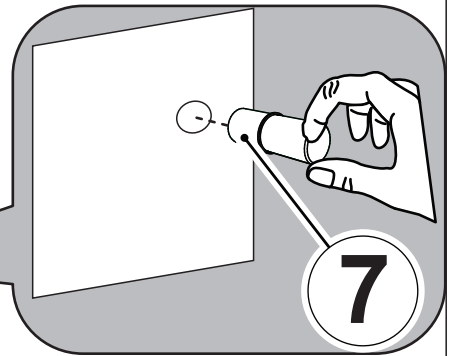
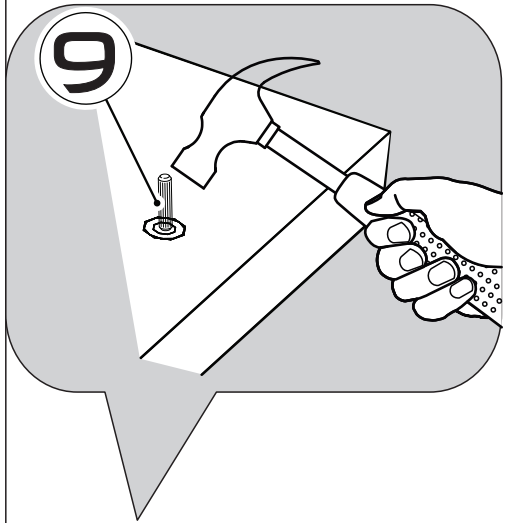
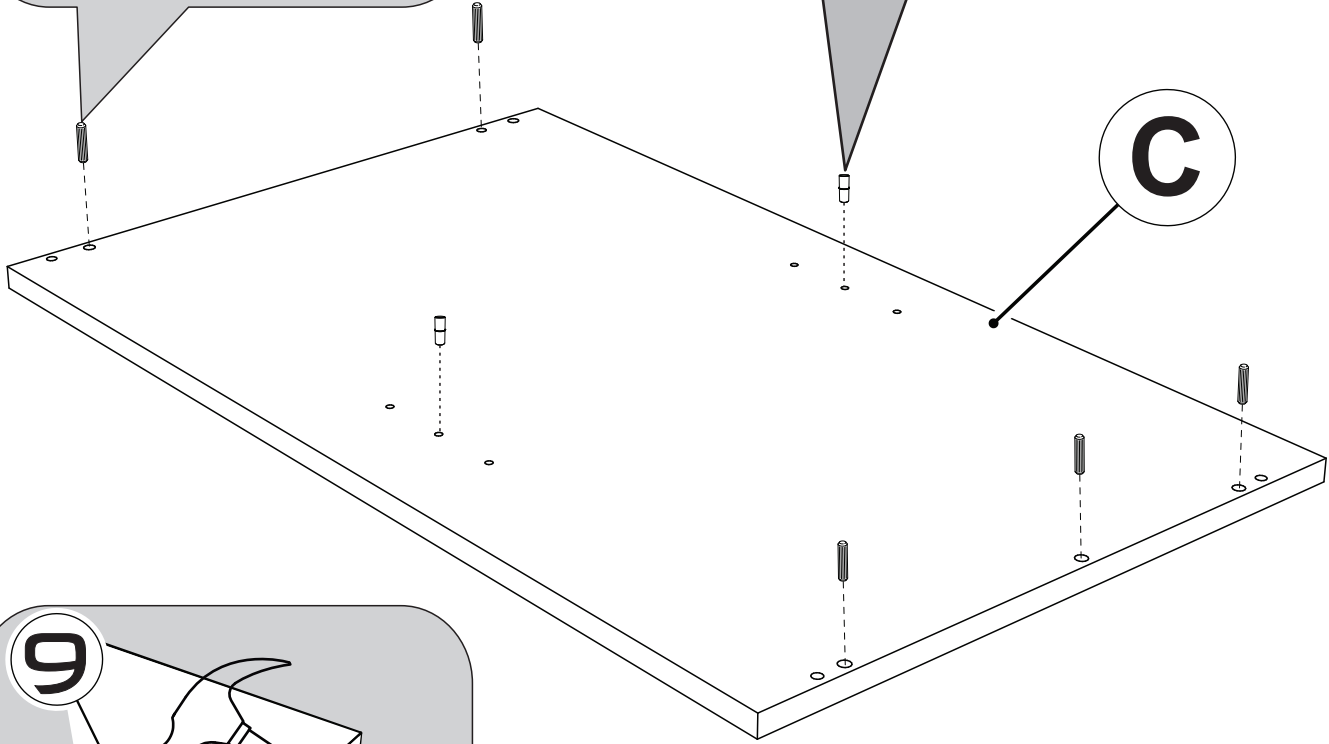
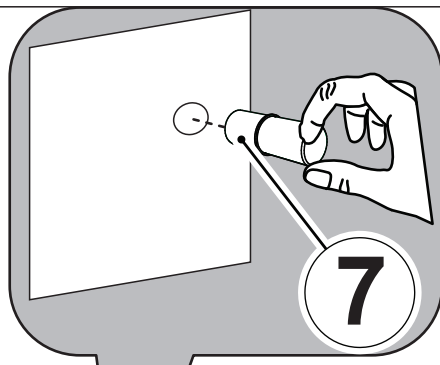
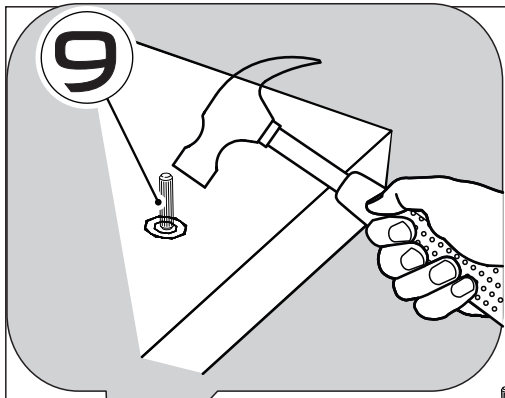

2

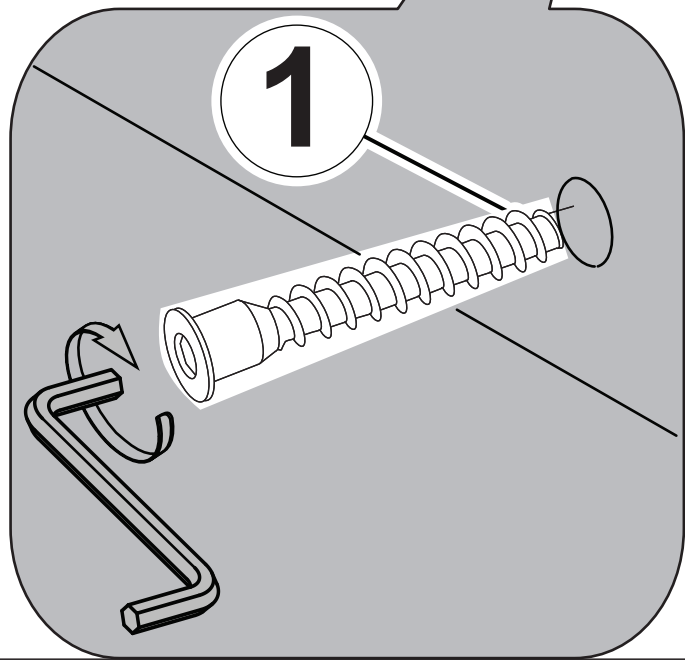
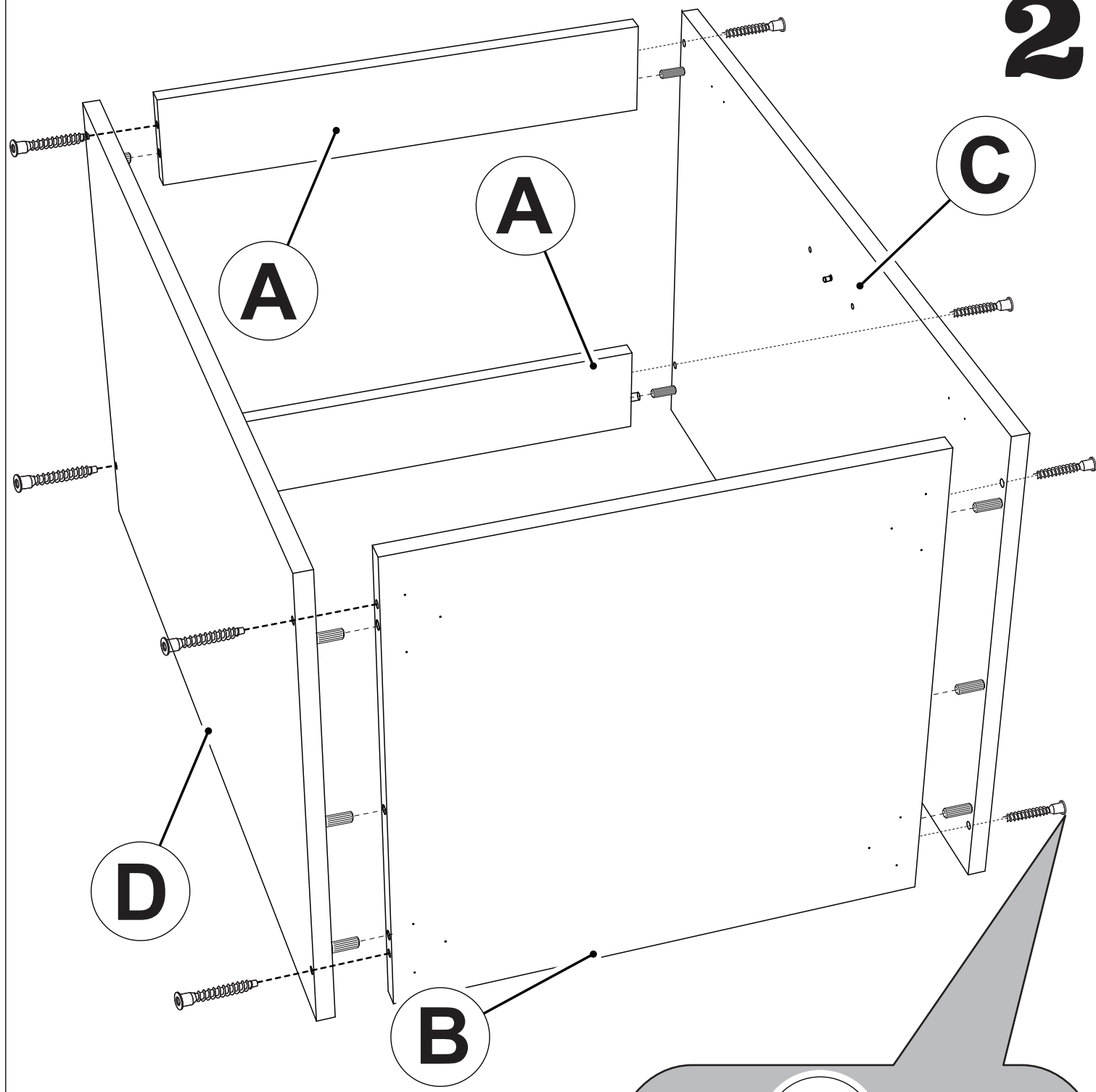

2

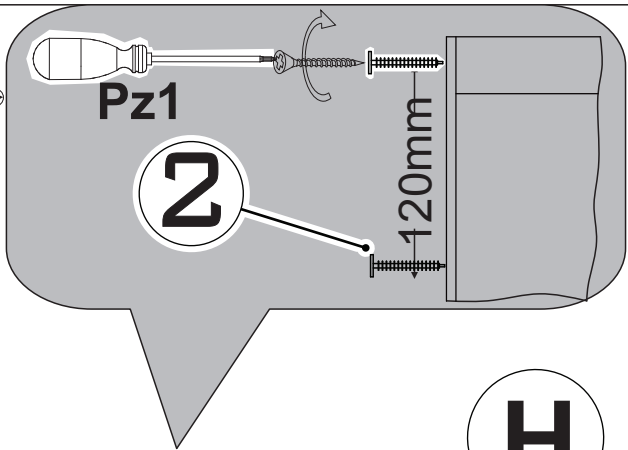

3

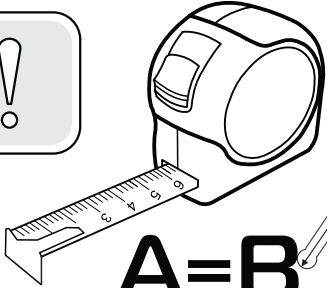

1

H

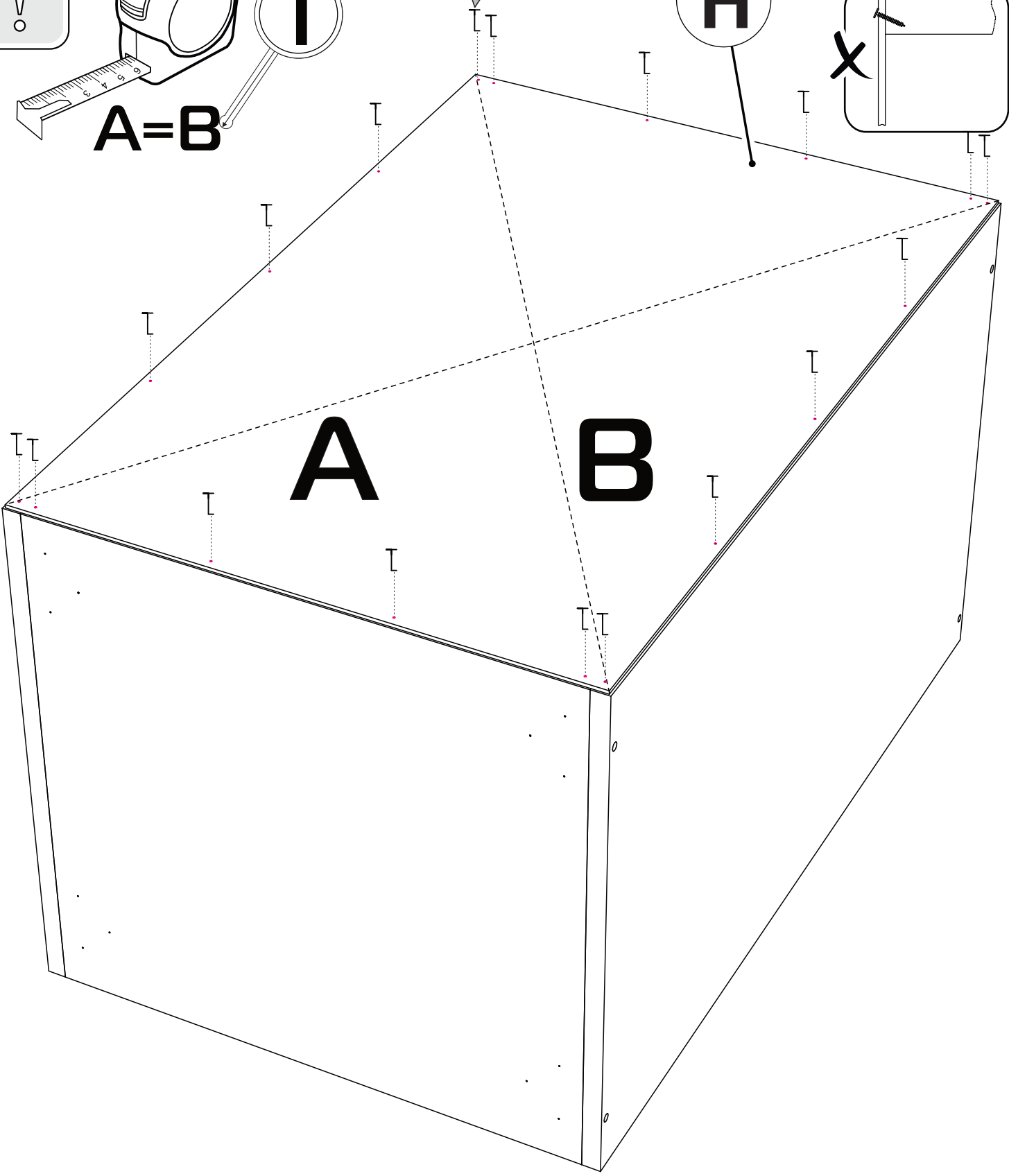
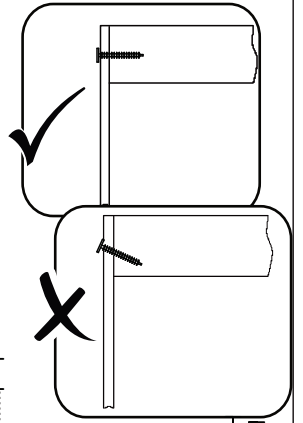

5

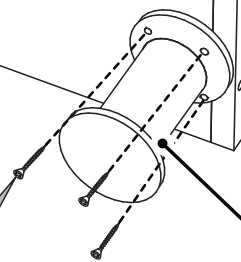
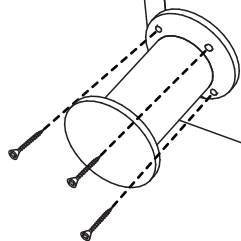
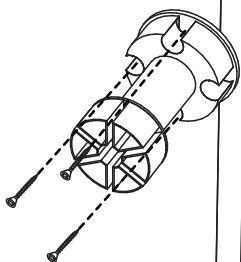
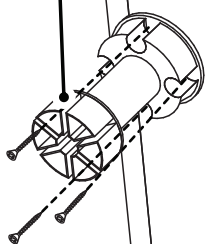

6

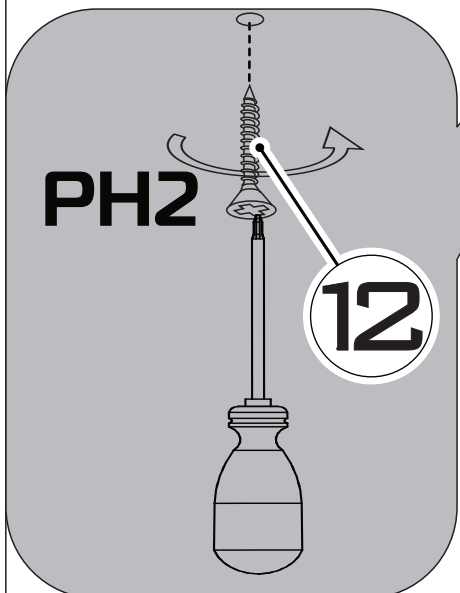

PH2

12

